

1 2 3 4 5 6 7 8 9 10 11 12 13 14 15 16

A
B
C
D
E
F
G
H
I
J
K
L

A
B
C
D
E
F
G
H
I
J
K
L

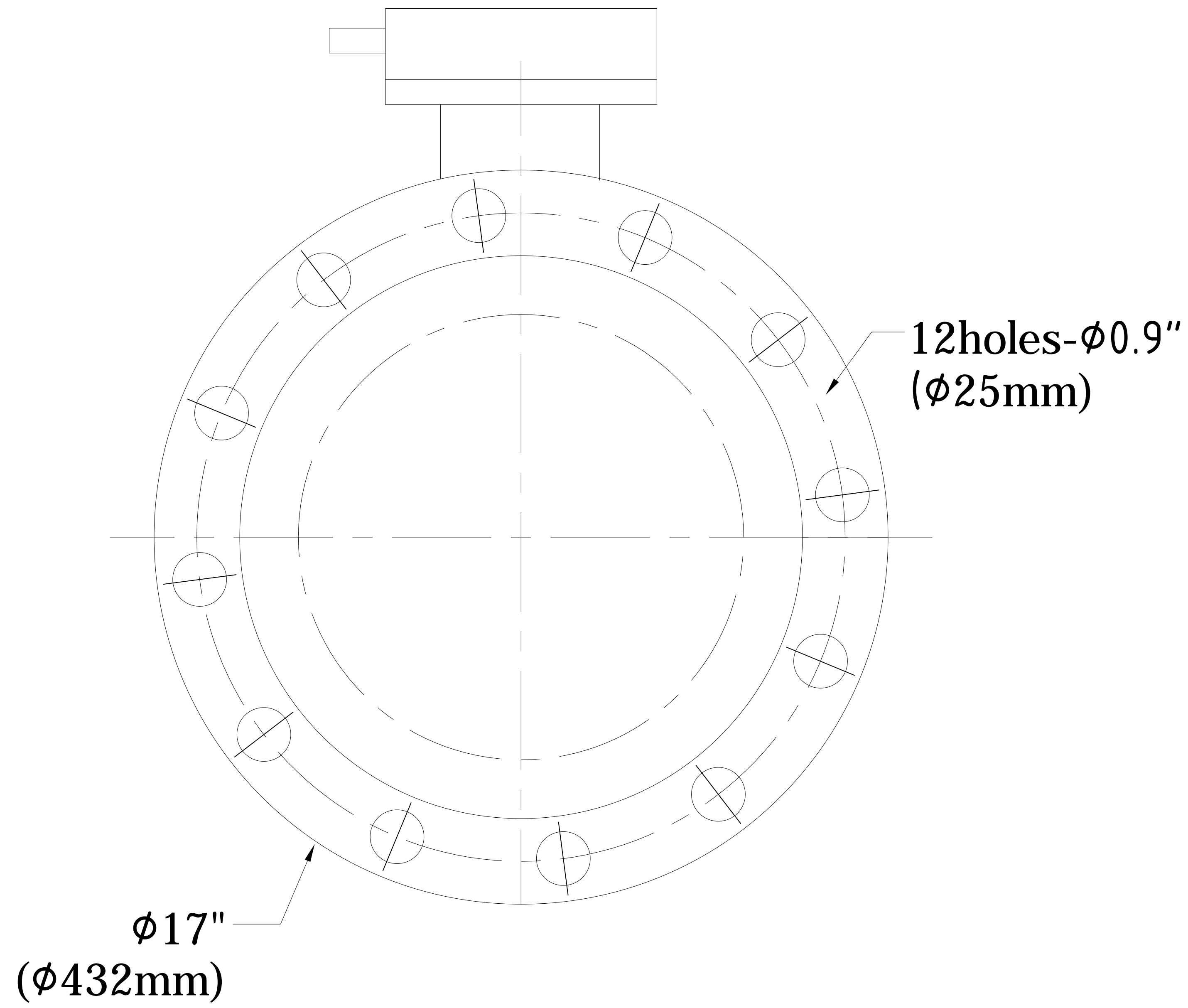
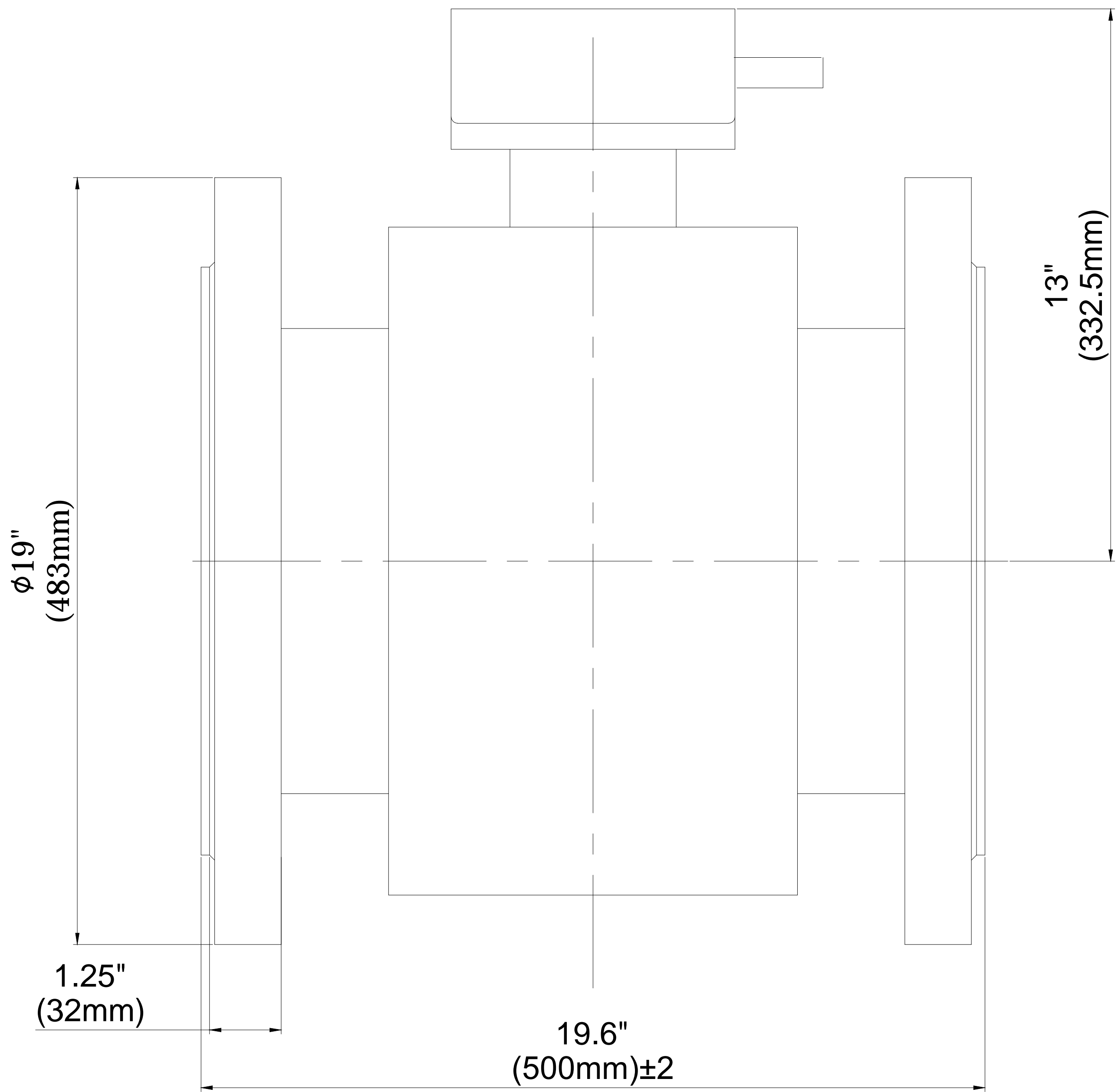

MODEL NO-TEK-FLUX 1400A

DN	12"
Accuracy	0.5%
Power Supply	18~36VDC or 85-260VAC
Working pressure	0-290Psi
working temp.	-4~+176F
Flow Range	1118.3-11183GPM
Structure	Remote type
Flange Standard	ANSI B 16.5 CL 150

CUSTOMER :	
CUSTOMER DWG NO :	
P.O.NO :	S.O.NO :
PROJECT NAME :	
Drawing is not Certified,Certified drawing are available on request. Dimensions are nominal and may be vary slightly the actual product.	

ANGLE:	SCALE: 1:1	SIZE: A1	REV: 00
TEKTROL Tek-Trol LLC			
TITLE: TEK-FLUX 1400A			
DR.: JST	07 JAN 2018	DRAWING NO.:	
APP'D: KNU	07 JAN 2018	1400A-GA-30	
PRODUCT CODE: 1400		SHEET: 1 OF 1	